

- 62.50 MHz IF SAW Filter / 19.20MHz Bandwidth
- Revision 0: 11 Apr. 2008

Electrical Characteristics

MAXIMUM RATING				
Parameters Description	Unit	Minimum	Typical	Maximum
Operating Temperature Range	°C	-30	-	60
Storage Temperature Range	°C	-40	-	85
Maximum DC Voltage	V	-	-	10
Maximum Input Power	dBm	-	-	10
Source Impedance (single ended) ⁽¹⁾	Ω	-	50	-
Load Impedance (single ended) ⁽¹⁾	Ω	-	50	-
Package type & size	T			
Length x Width	mm ²	-	9.1 x 4.8	-
Height	mm	-	-	1.5

ELECTRICAL SPECIFICATION				
Parameters Description	Unit	Minimum	Typical	Maximum
Center Frequency (Fo)	MHz	-	62.50	-
Insertion Loss at Fo	dB	-	19.0	20.5
Group Delay Variation at Fo±9.22MHz	nsec	-	30	80
Absolute Delay at Fo	usec	-	0.98	-
Passband Ripple at Fo±9.22MHz	dB	-	0.70	1.0
Bandwidth at -1dB	MHz	18.70	19.20	-
Bandwidth at -5dB	MHz	-	20.60	-
Bandwidth at -7dB	MHz	-	20.95	-
Bandwidth at -40dB	MHz	-	25.60	26.50
Relative Attenuation:				
Lower sidelobe	dB	40	45	-
Upper sidelobe	dB	40	45	-

Notes : (1) With Matching Network (Ref. Testing Environment Circuit as shown below).
Those impedances could be modified with different impedance values and/or structures, if necessary.

Package Dimensions

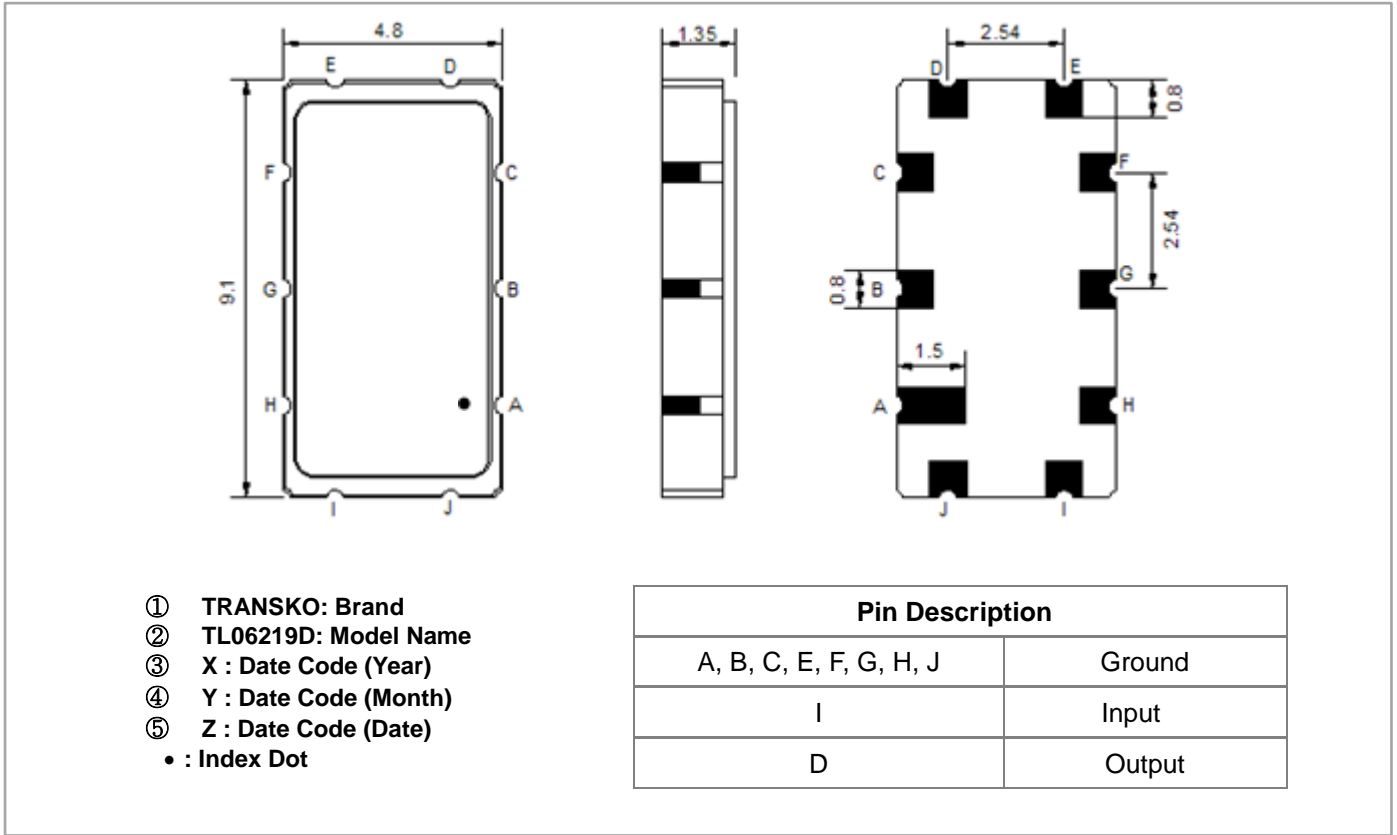

Testing Environment

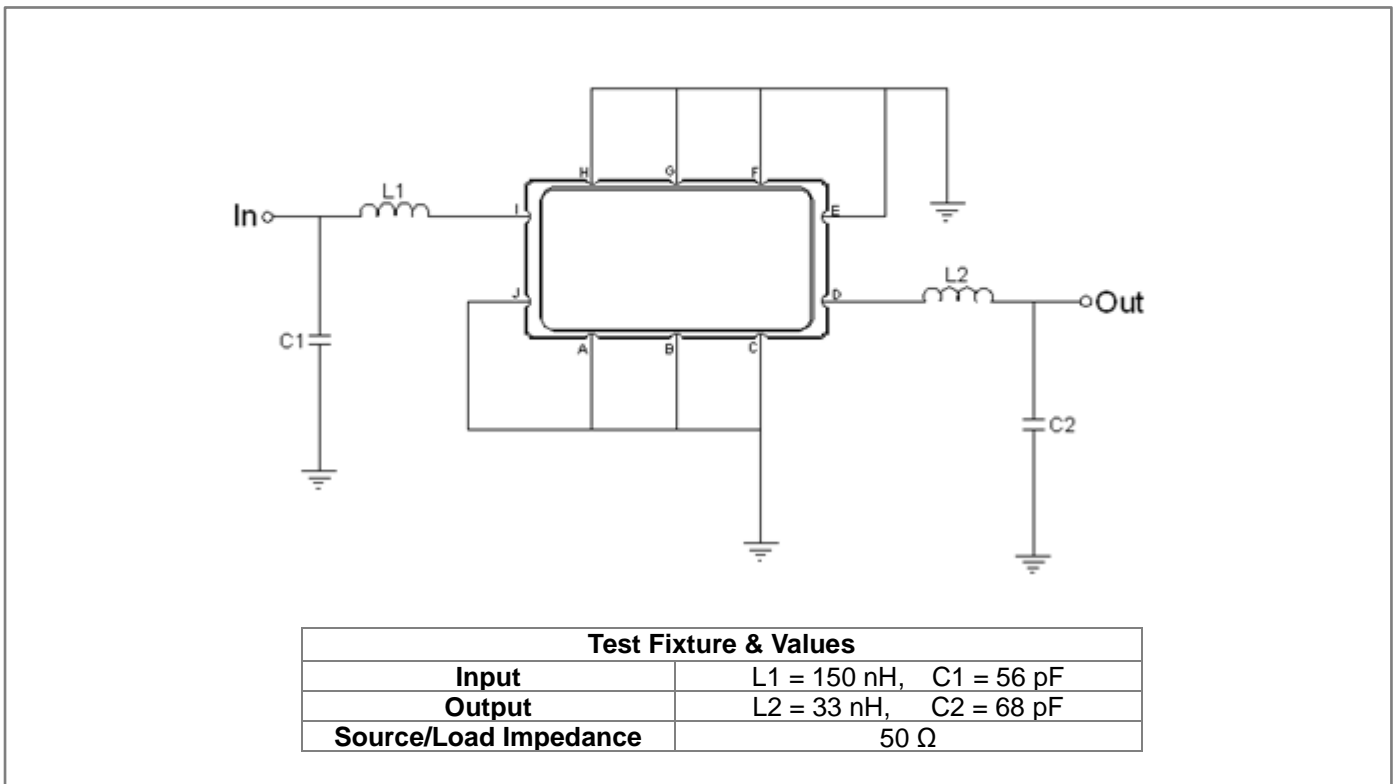

Frequency Characteristics

Frequency Response

Bandwidth at -1.0 dB

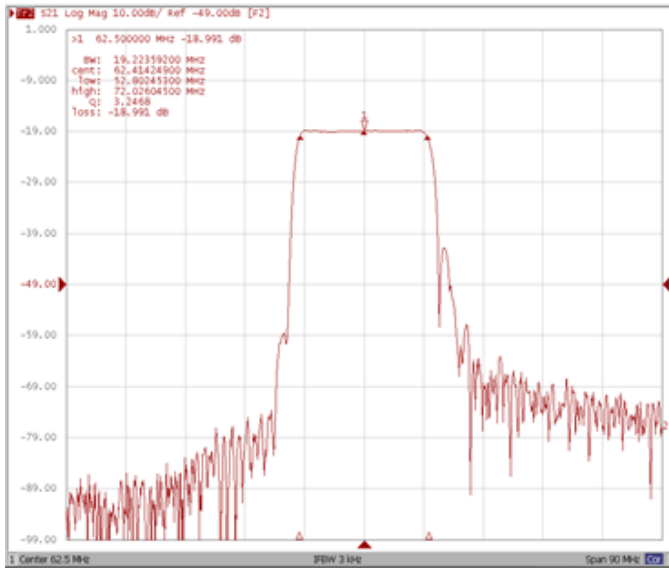

Bandwidth at -5.0 dB

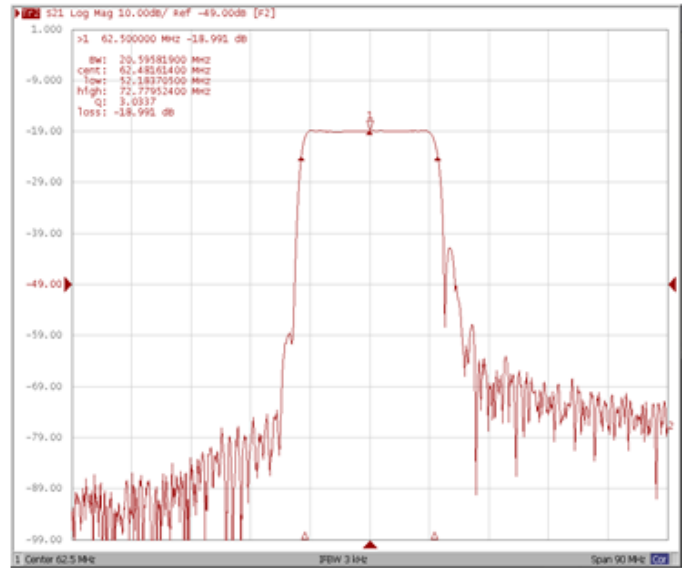

Bandwidth at -7.0 dB

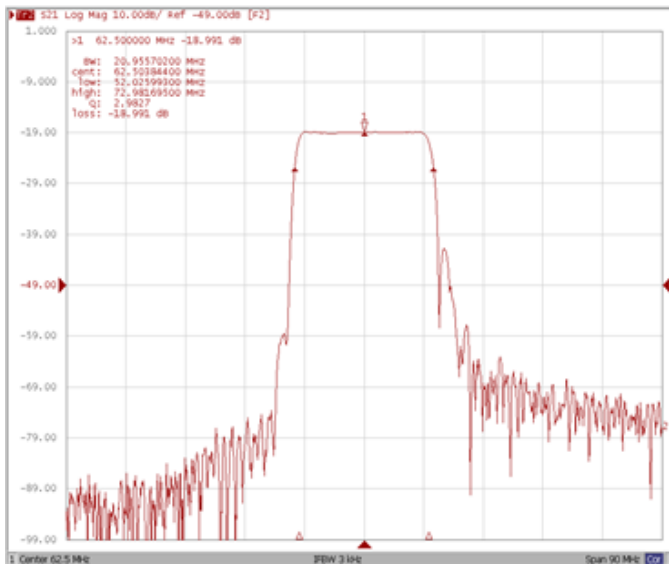

Wide-Band

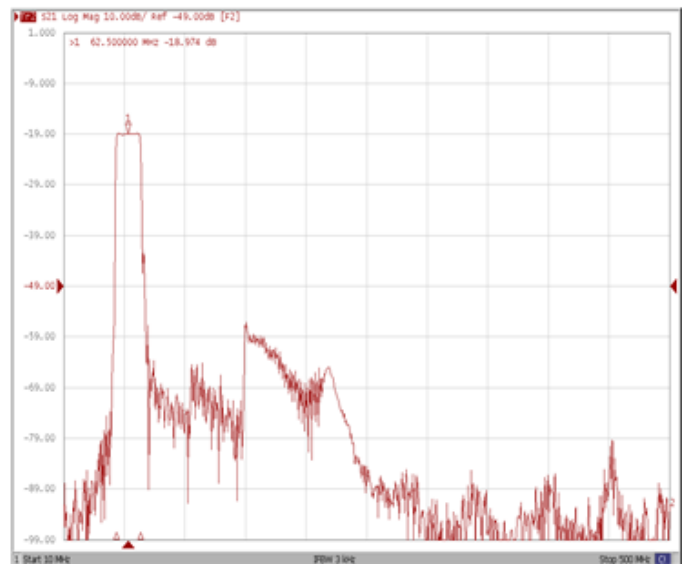

Frequency Response

Ripple Variation Fo ±9.22MHz

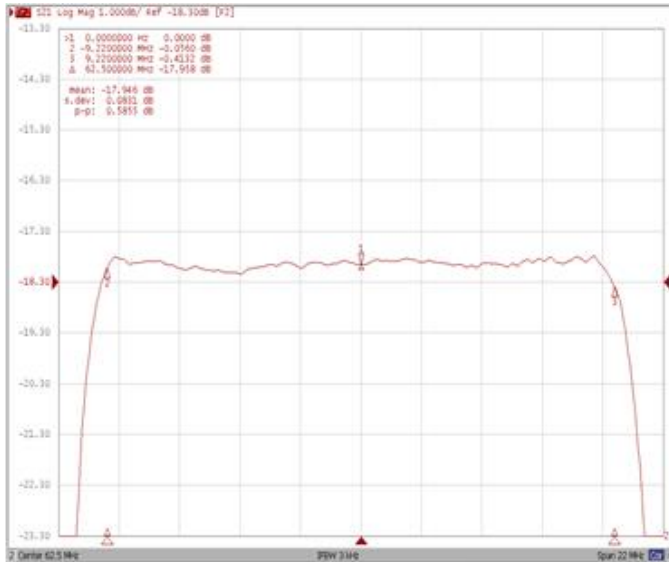

Group Delay Variation Fo ±9.22MHz

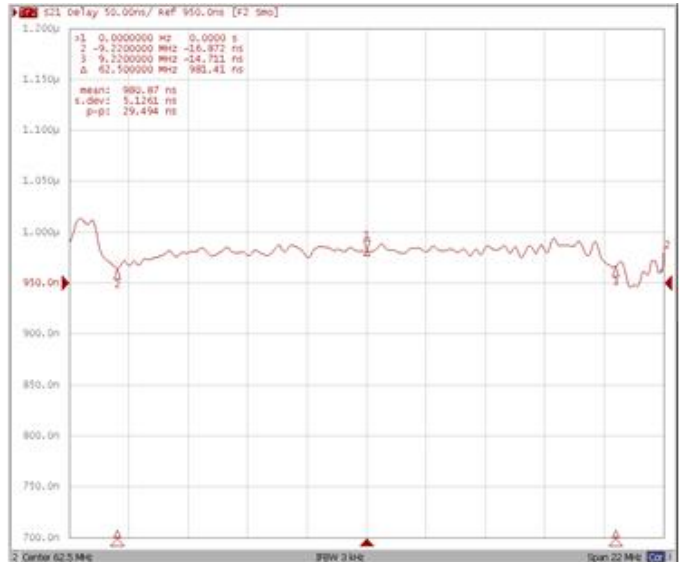

Smith Chart

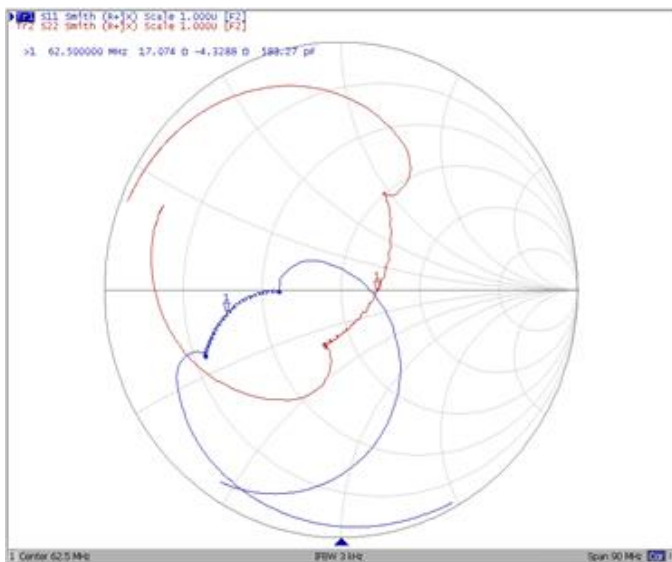

SWR

