

- 65.0 MHz IF SAW Filter / 29.55 MHz Bandwidth
- Revision 0: 26 Oct. 2009

Electrical Characteristics

MAXIMUM RATING				
PARAMETERS DESCRIPTION	UNIT	MINIMUM	TYPICAL	MAXIMUM
Operation Temperature Range	°C	-5	-	70
Storage Temperature Range	°C	-40	-	85
Maximum DC Voltage	V	-	-	10
Maximum Input Power	dBm	-	-	10
Source Impedance (single ended) ⁽¹⁾	Ω	-	50	-
Load Impedance (single ended) ⁽¹⁾	Ω	-	50	-
Package type & size	D1			
Length x Width	mm ²	-	20.0 x 9.8	-
Height	mm	-	-	1.8

ELECTRICAL SPECIFICATION				
PARAMETERS DESCRIPTION	UNIT	MINIMUM	TYPICAL	MAXIMUM
Center Frequency (Fo)	MHz	-	65.0	-
Insertion Loss at Fo	dB	-	29.5	-
Group Delay Variation at Fo ± 14.32 MHz	nsec	-	32	100
Absolute Delay at Fo	usec	-	2.47	-
Passband Ripple Variation at Fo ± 14.32 MHz	dB	-	0.57	1.00
Bandwidth at -1dB	MHz	29.30	29.55	-
Bandwidth at -3dB	MHz	-	29.85	-
Bandwidth at -40dB	MHz	-	31.38	31.45
Ultimate Rejection	dB	46	50	-
Temperature Coefficient	ppm/°C	-	-72	-

Notes : (1) With Matching Network (Ref. Testing Environment Circuit as shown below).
Those impedances could be modified with different impedance values and/or structures, if necessary.

Package Dimensions

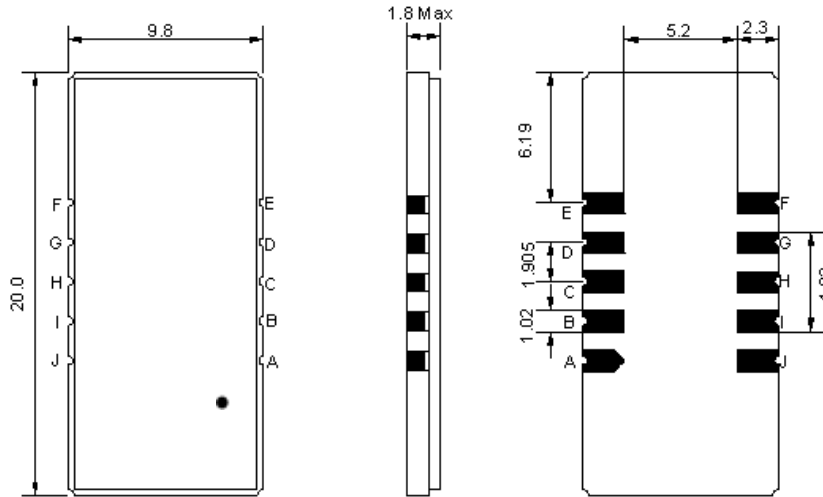

- ② TRANSKO: Brand
- ② TA06529A: Model Name
- ③ X : Date Code (Year)
- ④ Y : Date Code (Month)
- ⑤ Z : Date Code (Date)
- : Index Dot

Pin Description	
A, B, C, D, F, G, H, I	Ground
J	Input
E	Output

Testing Environment

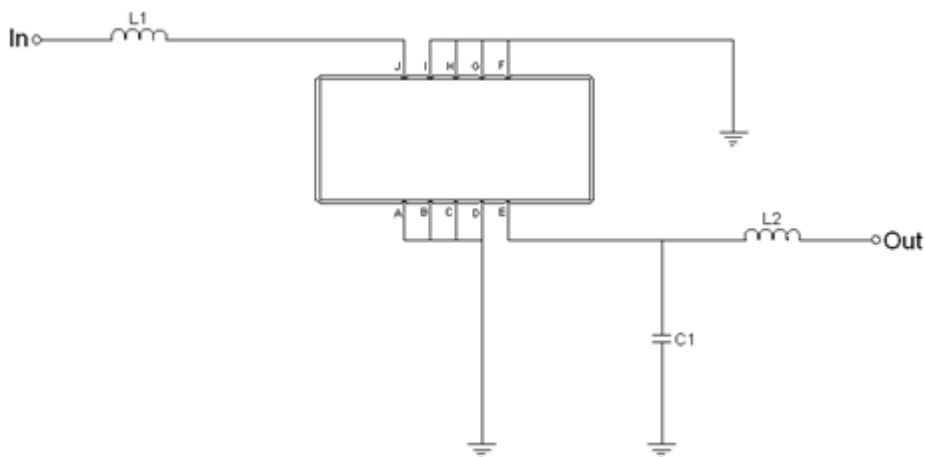

Test Fixture & Values	
Input	L1 = 150 nH
Output	L2 = 220 nH, C1 = 5 pF
Source/Load Impedance	50 Ω

Frequency Characteristics

Frequency Response

Bandwidth at -1.0 dB

Bandwidth at -3.0 dB

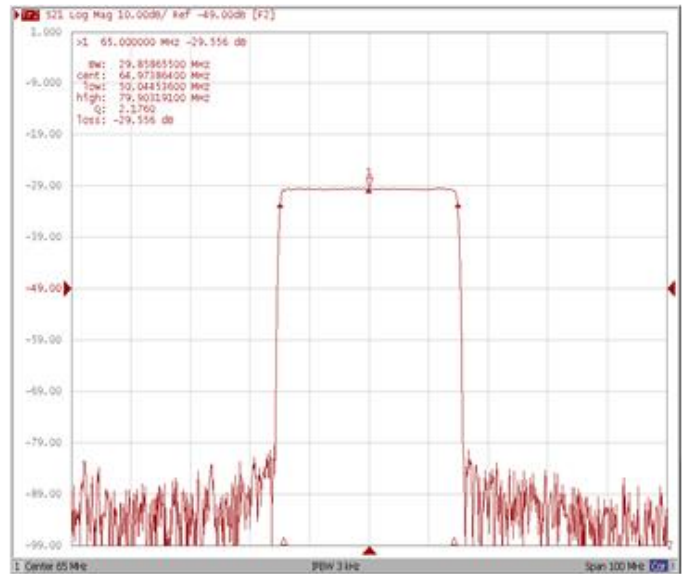
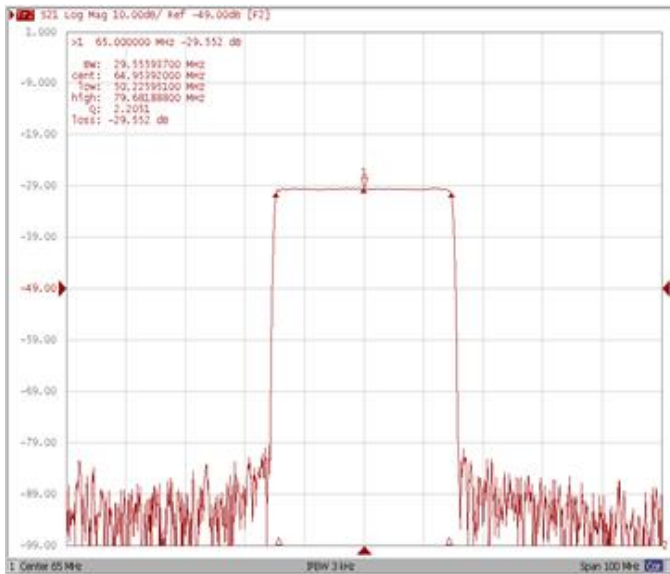

Bandwidth at -40.0 dB

Wide-Band

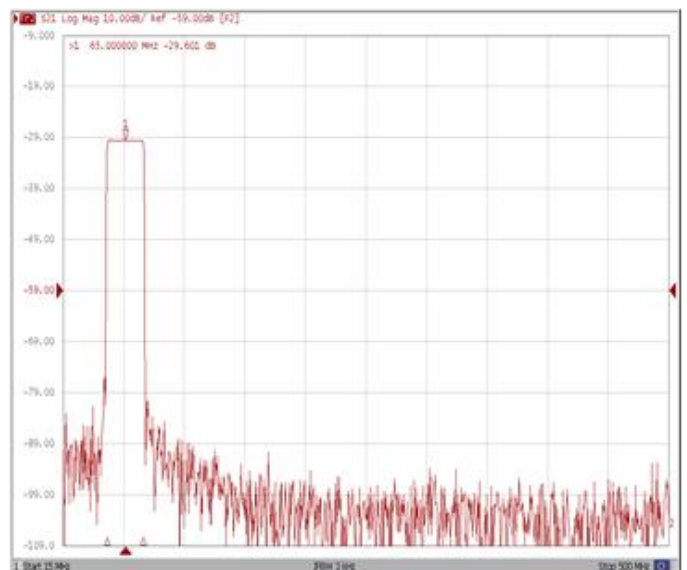
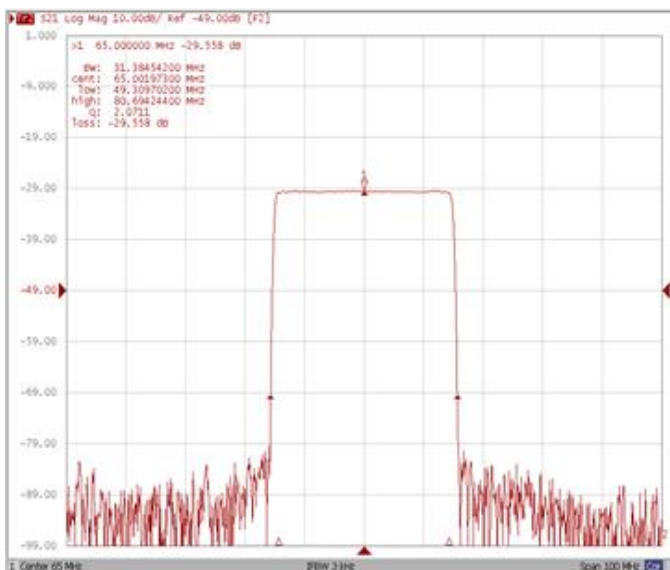

Frequency Response

Ripple Variation Fo±14.32MHz

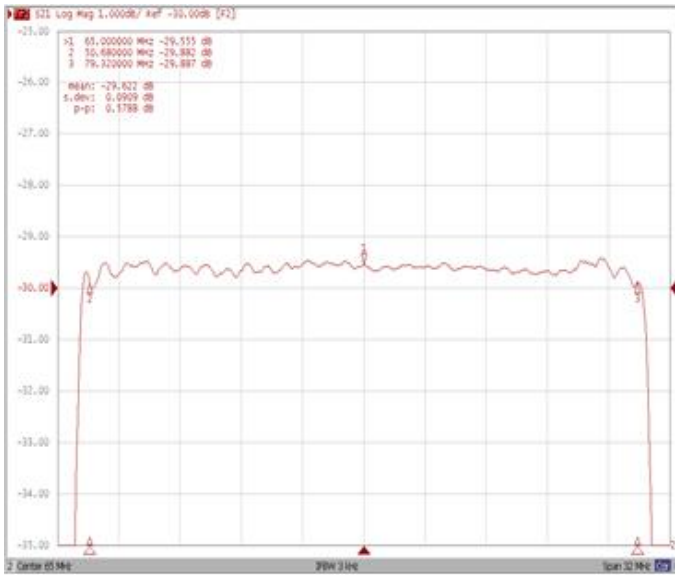

Group Delay Variation Fo±14.32MHz

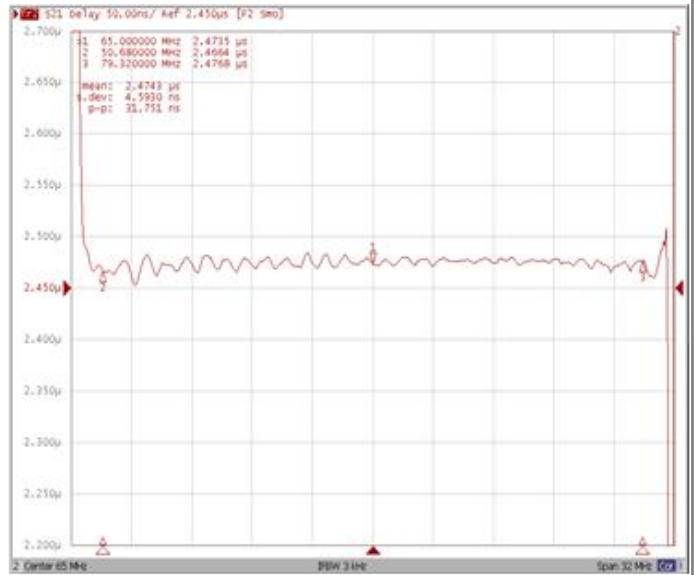

Smith Chart

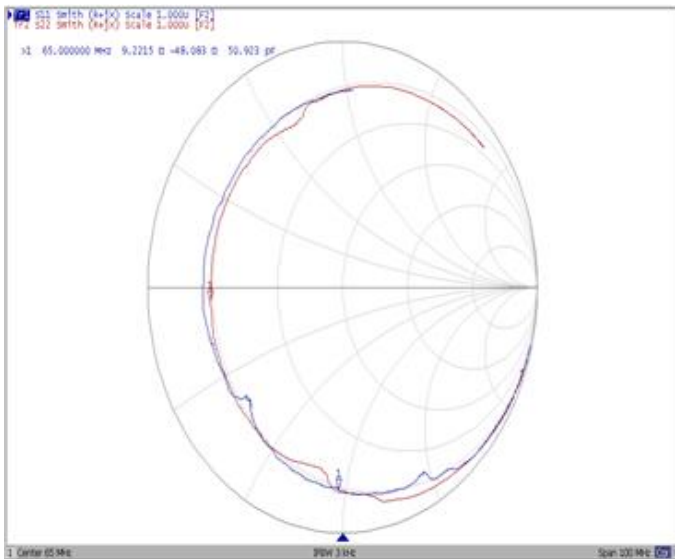

VSWR

