

FEATURES:

- WIDE FREQUENCY RANGE VCO
- LOW PHASE NOISE
- FAST DELIVERY / LOW COST

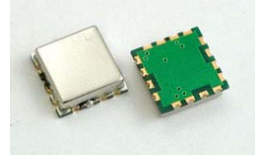

MODEL	FREQ. RANGE (MHz)	PHASE NOISE @ 10KHz (dBc/Hz)	PHASE NOISE @ 1MHz (dBc/Hz)	TUNING VOLTAGE Vr(V)	TUNING SENSITIV. (MHz/V)	HARMONIC SUPPRESSION (dBc) typ.	POWER OUTPUT Po(dBm)	SUPPLY VOLTAGE (Vcc)	CURRENT Icc (mA)
TVCO-038	25 ~ 50	-125	-152	0 ~ 12	3	-12	6 ± 3	5	15
TVCO-070	67 ~ 73	-120	-162	0.5 ~ 4.5	3	-10	0 ± 2	5	15
TVCO-075	50 ~ 100	-123	-150	0 ~ 12	5	-12	6 ± 3	5	15
TVCO-150	100 ~ 200	-119	-150	0 ~ 15	8	-12	6 ± 3	5	15
TVCO-190	140 ~ 160	-118	-162	0.5 ~ 4.5	3	-12	0 ± 2	5	15
TVCO-200	185 ~ 195	-118	-162	1.0 ~ 4.0	3	-17	0 ± 2	5	15
TVCO-233	223 ~ 243	-115	-160	0.5 ~ 4.5	6	-16	0 ± 2	3	15
TVCO-300	250 ~ 350	-112	-152	1.0 ~ 10	1.4	-16	0 ± 3	5	15
TVCO-348	305 ~ 392	-105	-148	0 ~ 5	20	-10	8 ± 2	5	15
TVCO-360	360 ~ 410	-113	-153	0.5 ~ 4.5	14	-15	3 ± 3	5	15
TVCO-380	370 ~ 390	-115	-160	0.5 ~ 4.5	7	-15	0 ± 2	5	15
TVCO-450	400 ~ 500	-109	-148	1.0 ~ 9.0	1.5	-12	0 ± 3	5	15
TVCO-540	525 ~ 555	-110	-153	1.0 ~ 4.0	2	-11	2 ± 2	5	16
TVCO-580	570 ~ 590	-115	-160	1.0 ~ 4.0	7	-13	0 ± 2	5	15
TVCO-600	400 ~ 800	-100	-142	0.5 ~ 15	25	-15	7 ± 3	8	30
TVCO-669	649 ~ 689	-110	-155	0.5 ~ 4.5	12	-13	0 ± 2	5	15
TVCO-760	740 ~ 780	-113	-158	0.5 ~ 4.5	12	-15	0 ± 2	5	15
TVCO-830	810 ~ 850	-110	-155	0.5 ~ 4.5	12	-15	0 ± 2	5	15
TVCO-900	880 ~ 920	-110	-155	0.5 ~ 4.5	12	-15	0 ± 2	5	15
TVCO-940	920 ~ 960	-110	-155	0.5 ~ 4.5	12	-15	0 ± 2	5	15
TVCO-1093	1080 ~ 1105	-107	-148	0.5 ~ 4.5	9	-15	0 ± 2	5	15
TVCO-1050	900 ~ 1200	-100	-140	0.5 ~ 4.5	100	-15	2 ± 2	5	25
TVCO-1100	900 ~ 1300	-100	-140	0.5 ~ 12	45	-15	3 ± 2	5	25
TVCO-1138	1125 ~ 1150	-106	-146	0.5 ~ 4.5	10	-15	0 ± 2	5	15
TVCO-1175	1162 ~ 1187	-106	-146	0.5 ~ 4.5	10	-15	0 ± 2	5	15
TVCO-1250	1200 ~ 1300	-105	-145	0.5 ~ 4.5	30	-15	0 ± 2	5	15
TVCO-1500	1450 ~ 1550	-102	-142	0.5 ~ 4.5	32	-20	0 ± 2	5	15
TVCO-1540	1040 ~ 1540	-105	-145	0.5 ~ 20	28	-13	7 ± 3	5	30
TVCO-1550	1550 ~ 1650	-100	-140	0.5 ~ 4.5	32	-20	0 ± 2	12	15
TVCO-1600	1550 ~ 1650	-100	-140	0.5 ~ 4.5	32	-25	0 ± 2	5	15
TVCO-1650	1600 ~ 1700	-100	-140	0.5 ~ 4.5	32	-25	0 ± 2	5	15
TVCO-1660	1630 ~ 1690	-100	-140	0.5 ~ 4.5	32	-25	0 ± 2	3.3	15
TVCO-1760	1730 ~ 1790	-100	-140	0.5 ~ 4.5	30	-25	0 ± 2	5	15
TVCO-1810	1770 ~ 1850	-100	-140	0.5 ~ 4.5	30	-25	0 ± 3	5	15
TVCO-1850	1800 ~ 1900	-100	-140	0.5 ~ 4.5	32	-25	0 ± 2	5	15
TVCO-1870	1450 ~ 1870	-105	-142	0.5 ~ 20	23	-15	6 ± 2	12	30
TVCO-2000	1867 ~ 2131	-100	-140	0.5 ~ 4.5	85	-18	0 ± 3	5	20

Transko Electronics, Inc reserves the right to make changes to the product(s), service(s), and specification(s) described herein without notice. No liability is assumed as a result of their use or application.

MODEL	FREQ. RANGE	PHASE NOISE @ 10KHz	PHASE NOISE @ 1MHz	TUNING VOLTAGE	TUNING MHz/V	HARMONIC SUPPRESSION	POWER OUT(dBm)	SUPPLY VOLTAGE	CURRENT
TVCO-2050	2030 ~ 2070	-95	-138	30	0 ~ 3.3	-30	0 ± 1.5	3	12
TVCO-2100	2050 ~ 2150	-98	-140	33	0.5 ~ 4.5	-30	0 ± 2	5	15
TVCO-2130	2080 ~ 2180	-105	-145	55	0.5 ~ 3	-25	0 ± 2	5	20
TVCO-2150	2100 ~ 2200	-98	-140	33	0.5 ~ 2.5	-30	0 ± 2	5	15
TVCO-2250	2200 ~ 2300	-98	-140	35	0.5 ~ 4.5	-30	0 ± 3	5	15
TVCO-2350	2300 ~ 2400	-95	-136	35	0.5 ~ 4.5	-30	0 ± 2	5	15
TVCO-2425	2350 ~ 2500	-105	-145	43	0.5 ~ 4.5	-20	0 ± 2	5	25
TVCO-2600W	2510 ~ 2690	-104	-145	49	0.5 ~ 4.5	-25	0 ± 2	5	25
TVCO-2600	2400 ~ 2600	-100	-140	60	0.5 ~ 4.5	-30	6 ± 2	12	30
TVCO-3000	2900 ~ 3150	-95	-135	80	0.5 ~ 4.5	-25	0 ± 3	5	25
TVCO-3150	3100 ~ 3200	-90	-132	35	0.5 ~ 4.5	-30	0 ± 2	5	25

Note:

- Other frequency ranges and options are available upon request. Please contact Sales Associates at 1-714-491-8089 or sales@transko.com.
- Alternative replacements for **UMC, Sirenza, Z-comm, and Crystek.**

Package Drawing

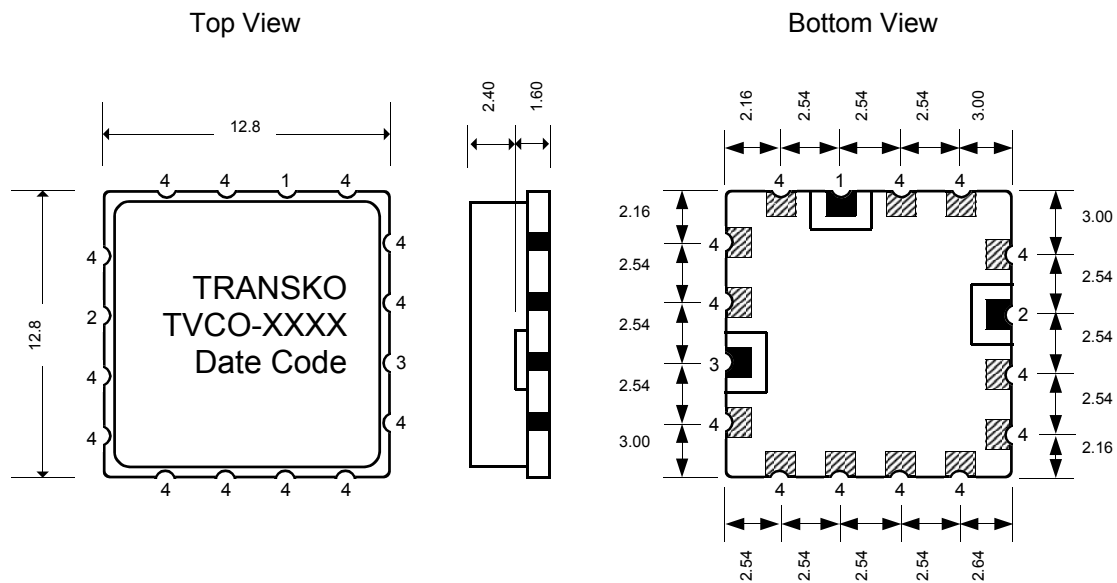

PIN CONNECTION	
1	VCC
2	VT
3	RF
4	GROUND

mm
(inch)

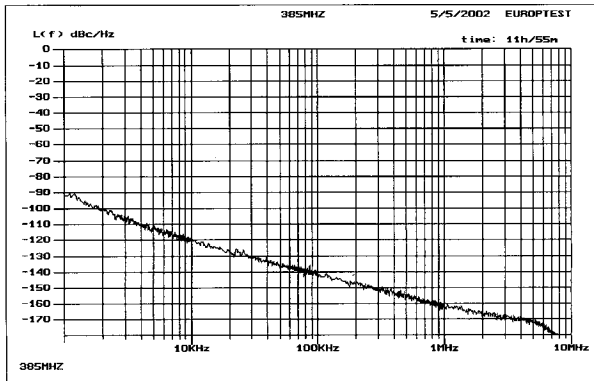
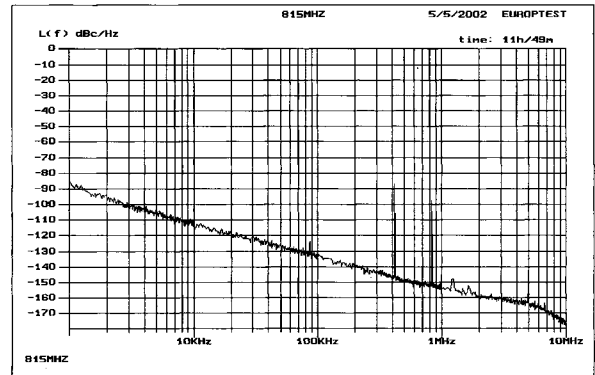
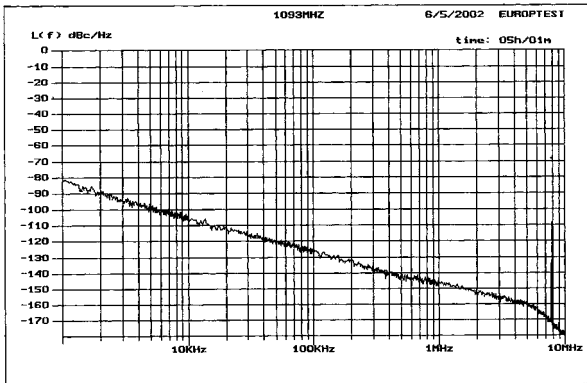
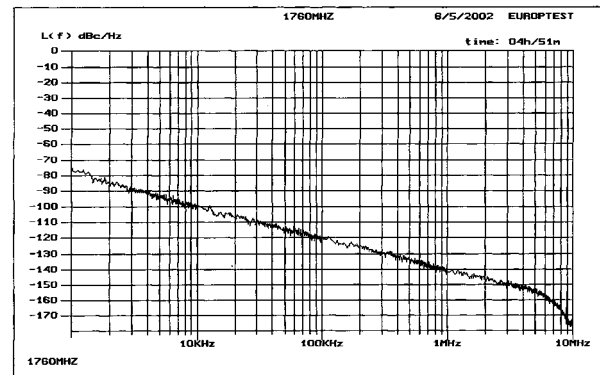
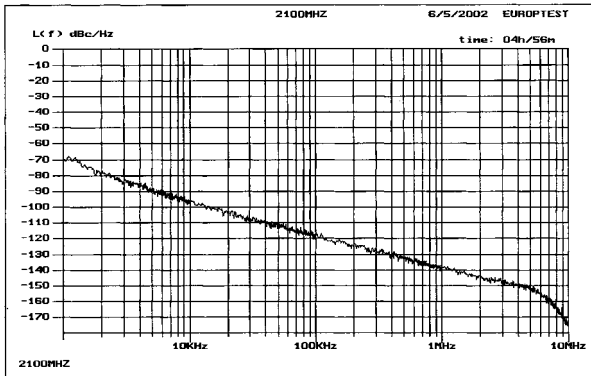
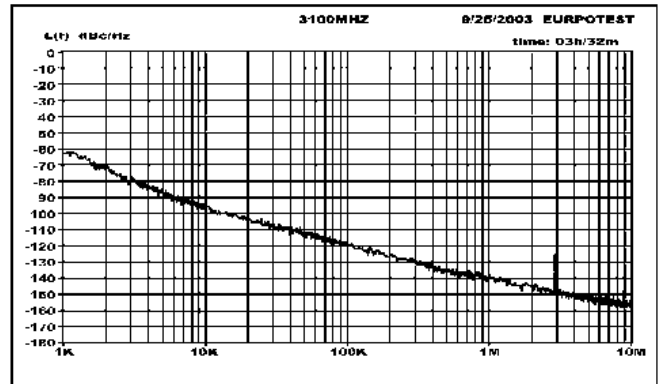
TVCO-380

TVCO-830

TVCO-1093

TVCO-1760

TVCO-2100

TVCO-3150